

Questo disegno e' di proprieta' di OIOLI Rubinerie che, a norma di legge, si riserva tutti i diritti.
 This drawing is the property of OIOLI Rubinerie and must not be copied in part or whole without prior written permission of OIOLI Rubinerie.

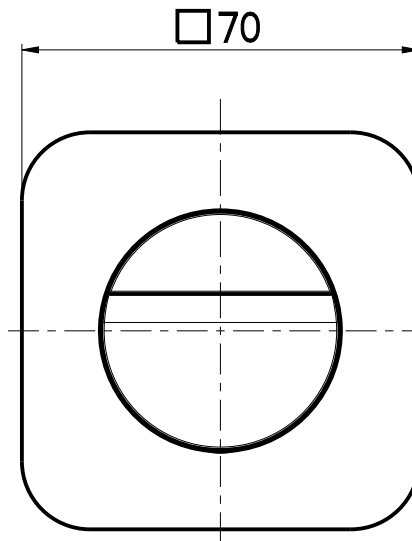
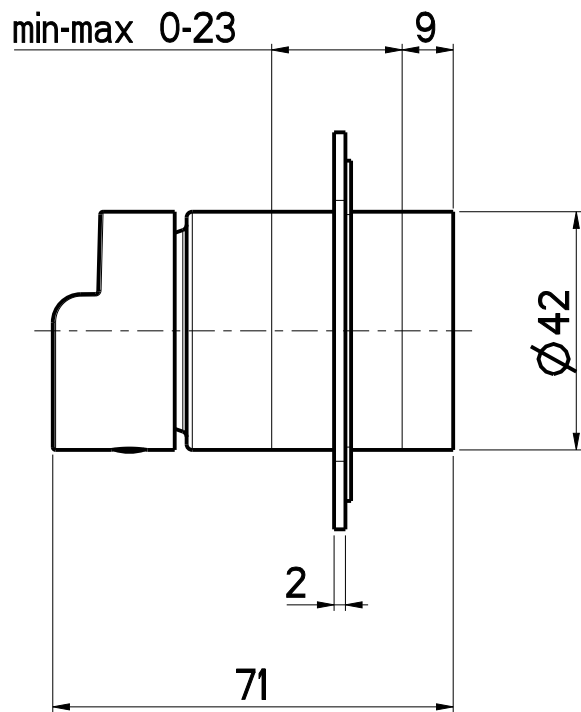

OIOLI
RUBINETTERIE
 e-mail: mattia@oioli.com
 Via Pul Stretta, 10/12
 28024 Gozzano (No) Italy
 Tel. 0322 956338
 Fax 0322 912094

DATA	5/8/2025	VERSIONE	PROGETTO	SCALA	CODICE DISEGNO	
DISEGNATORE	B.F.	1.2		3:4	OIHOER385RO	
DESCRIZIONE						ARTICOLO
PARTI ESTERNE RUBINETTO DI ARRESTO HOP						HOER385RO